

2024年08月版

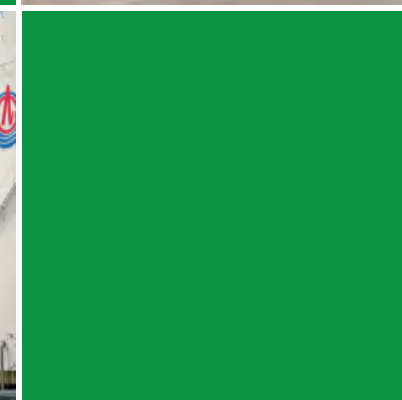

EXPERTISE
DELIVERS QUALITY
品质源于专业

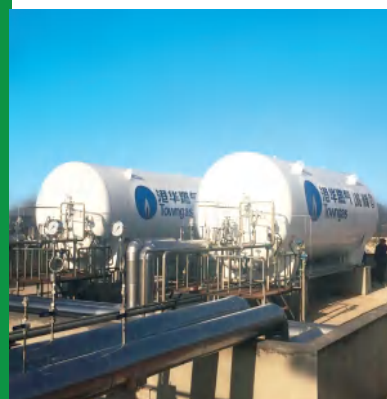

地址：江苏无锡经济开发区(胡埭园区)鸿翔路33号
电话：+86(510)8558-3001 8558-3002
传真：+86(510)8558-3188 8558-3288
邮箱：sales@triumph-china.com
网址：www.triumph-china.com (国内)
www.cryotriumph.com (国际)

Add: No.33 Hongxiang Road, Wuxi Economic Development
Zone (Hudai Town), Jiang Su, China
Tel: +86 (510) 8558-3001 8558-3002
Fax: +86 (510) 8558-3188 8558-3288
E-mail: sales@triumph-china.com
Web: www.triumph-china.com (Domestic)
www.cryotriumph.com (International)



无锡特莱姆气体设备有限公司
Wuxi Triumph Gases Equipment Co., Ltd.

www.triumph-china.com



24 小时客户服务热线 4008288368
24/7 Customer Service Hotline

行业领先的
Industry-leading

工业气体及燃气装备整体
Industrial Gases & LNG Equipment

解决方案全球供应商
Global supplier of solutions



荣获行业首张碳中和证书
Award the industry's first Carbon
Neutrality Certificate



Contents 目录

- 01 公司简介
Company Profile
- 03 公司一角
Company Corner
- 05 公司成长 & 服务分类
Business Growth & Service Category
- 07 领导关怀 & 优秀团队
Leadership Care & Excellent Team
- 09 资质与荣誉
Certificates & Honors
- 11 低温液体储罐系列
Cryogenic Liquid Storage Tank Series
- 12 特易捷迷你罐
TRIUMPH Micro-tank
- 13 液氢储罐系列
Liquid Hydrogen Storage Tank Series
- 14 冷箱产品系列
Cold Box Product Series
- 15 空温式气化器系列
Ambient Vaporizer Series
- 17 电加热式气化器系列
Electric Heated Vaporizer Series
- 18 燃烧式气化器系列
Combustion Vaporizer Series
- 19 中间介质气化器产品
Intermediate Fluid Vaporizer Products
- 20 LNG气化站撬装系列
LNG Vaporizing Skid Series
- 21 PLC站控系统
PLC Station Control System
- 22 LNG、L-CNG气化站项目EPC总包
EPC Turnkey Project of LNG & L-CNG Station
- 23 融资租赁业务 & 品牌代理
Financial Leasing Business Agency
- 25 项目现场
Jobsite
- 26 销售网络
Sales Network
- 27 客户现场
Onsite Service
- 28 行业影响
Industry Influence
- 29 长期荣誉客户 & 展望未来
Long Term Honored Customers & Future Outlook

公司简介
Company Profile



公司外景
Exterior View of Triumph



公司全景
Overall View of Triumph

- 20+
成立于2004年
- 60+
公司占地
(非租赁)
- 300+
员工数量300+
- 30+
核心人员行业经验
- 108
专利证书
- 80+
出口国

- 20+
Established in
2004
- 60+
Total Yard
(Non leasing)
- 300+
Employees
- 30+
Core Personnel
Industry Experience
- 108
Patent Certificate
- 80+
Export Country

无锡特莱姆气体设备有限公司创立于2004年，总部设在无锡经济开发区胡埭园区，是国家高新技术企业，2023年获工信部“国家级专精特新小巨人”称号，参编多个气体设备国家标准，并拥有108项国家专利，专业从事工业气体、燃气行业以及氢能行业等各类储存、气化等设备的研发、生产、销售和服务，可提供项目EPC总承包服务。

20多年来，公司产品不断创新迭代，始终以高质量发展为己任，主要产品有：各类高性能低温液体储罐、超高压液氢气化器、高效除雾气化器、低温循环水气化器、SCV、IFV、OHV等高效气化器系列，以及液氢液氮冷箱外壳等。产品已广泛应用于林德、液空、AP、梅塞尔、日酸、岩谷等所有外资气体集团以及广钢气体、金宏气体、杭氧气体、侨源气体等上市气体公司，中科院系统，深受用户一致好评。

目前公司年产值超过3.5亿元，拥有300名员工，其中包括一大批30多年专业从事气体（燃气）设备、压力容器设计制造经验的资深设计师和优秀员工。公司可为国内外客户提供各国标准的高品质的气体（燃气）设备，年产量可达6000台/套，产品出口量居行业领先，已出口80多个国家和地区。

公司资质

- 美国机械工程师协会ASME U钢印
- 欧盟CE钢印
- 加拿大CRN证书
- A2级压力容器制造许可证(含设计)
- 压力管道元件制造许可证
- GC2级压力管道安装许可证
- 中国船级社（CCS）认证
- 进出口许可证

主要荣誉

- 国家级专精特新小巨人企业
- 拥有108项国家专利
- 中国核电集团合格供应商
- 国家高新技术企业
- 民营科技型企业
- 中国压力容器委员会会员单位
- 中国气体协会会员单位
- 中国城市燃气协会会员单位
- 江苏省质量优胜单位
- A级纳税信用等级
- 省级AAA信用企业
- 马德里国际商标注册

管理体系

- SGS国际认证
- ISO9001国际质量体系认证
- ISO14001环境管理体系认证
- GB/T20881职业健康安全管理体系认证

主要产品

- 低温液体储罐系列
- 低温液体气化器
- 天然气撬装系列
- 气体减压装置系列
- PLC站控系统（无人值守）
- 品牌设备代理融资租赁业务
- 低温（工业气体、燃气）工程咨询、设计、制造、安装、调试、服务、EPC总承包业务

荣誉客户

- 工业气体
LINDE、AIR LIQUIDE、PRAXAIR、APCI、MESSER、SANSO
IWATANI、YINDE、广钢气体、杭氧气体、金宏气体、侨源气体.....
- 燃气行业
港华燃气集团、华润燃气集团、中国燃气集团、中海油集团、
中石油集团、中石化集团、中国天然气集团、新奥集团、广汇集团.....

TRIUMPH was founded in 2004 and is headquartered in Wuxi, China. It is National High-Tech Enterprise. In 2023, it was awarded "National Specialized Little Giant" by the Ministry of Industry and Information Technology. It has participated in the compilation of multiple national standards for gas equipment and holds 108 national patents. It specializes in the research and development, production, sales and services of various storage, vaporizing and other equipment in the industrial gas, fuel gas and hydrogen energy industry, and can provide project EPC general contracting services. For more than 20 years, the company's products have been continuously innovated and iterated, and it has always taken high-quality development as its mission. The main products include: various high-performance cryogenic liquid storage tanks, ultra-high pressure liquid hydrogen vaporizers, high-efficiency demisting vaporizers, low-temperature circulating water vaporizers, SCV, IFV, OHV and other high-efficiency vaporizer series, as well as liquid hydrogen and liquid helium cold box shells, etc. The products have been widely used by all global leading gas companies i.e. Linde, Air Liquide, AP, Messer, Nippon Sanso, Iwatani, as well as listing gas companies i.e. Guanggang Gas, Jinhong Gas, Hangzhou Oxygen Gas, Qiaoyuan Gas, and the Chinese Academy of Sciences system, and are well received by users. At present, the company's annual revenue exceeds 350 million yuan, with 300 employees, including a large number of senior designers and excellent employees with more than 30 years of professional experience in the design and manufacture of Industrial Gases/Fuel Gases equipment and pressure vessels. The company can provide domestic and international customers with high-quality Industrial Gases/Fuel Gases equipment per various national standards, with an annual deliveries of up to 6,000 units/sets. TRIUMPH exportation ranks second to none in the industry and has been exported to more than 80 countries and regions.

CERTIFICATES

- ASTM, ASTM U Stamp
- CE Certificate for EU
- Canada CRN Certificate
- License of Manufacturing for "A2 Pressure Vessel" (Including design)
- License of Design and Manufacturing for "Grade Pressure Piping"
- License of Installation for "Grade-GC2 Pressure Pipeline"
- China Classification Society (CCS) certificate
- Authorization of License of Import and Export

AWARDS

- National level specialized and innovative little giant
- 108 national patents
- Preferred Supplier by China Nuclear Power Group
- National Advance Technology Enterprise
- Private Science and Technology Enterprise
- Member of "China Transportable Pressure Vessel Committee"
- Member of "China Gas Association"
- Member of "China Municipal Gas Association"
- Superior Quality Unit in Jiangsu Province
- Class A Tax Credit Rating
- AAA Credit Enterprise in Jiangsu Province
- Madrid International Trademark

STANDARDS

- SGS International Certification
- ISO9001 International quality system certification
- ISO14001 Environmental management system certification
- GB/T28001 Occupational health and safety management system certification

MAJOR PRODUCTS

- Cryogenic tank
- Cryogenic Vaporizer
- Equipment Skid
- Gas Pressure Regulating Device
- PLC station control system (Remote)
- Brand equipment agency financial leasing business
- EPC Contracting for Industrial Gas (industrial gas, fuel gas) Project, Design, Manufacture, Installation, Commissioning and other Services.

HONORED CUSTOMERS

- Industrial Gases
LINDE, AIR LIQUIDE, PRAXAIR, APCI, MESSER, SANSO, IWATANI, BAOSTEEL, YINDE
- Fuel Gases (LNG)
Towngas, China Resources, China Gas, CNOOC, CNPC, Sino-pec, China LNG, ENN, GUANGHUI...

公司一角
Company Corner



低温储罐车间
Cryogenic Storage Tank Workshop



低温储罐车间
Cryogenic Storage Tank Workshop



空温气化器车间
Ambient Vaporizer Workshop



空温气化器车间
Ambient Vaporizer Workshop



水浴气化器车间
Water-bath Vaporizer Workshop



撬装产品车间
Skid Products Workshop



国家级“专精特新小巨人”称号

National Specialized and Sophisticated Little Giant Enterprises

企业文化
Corporate Culture

- 企业价值观——创造卓越产品就是推动社会进步
- 经营理念——合作发展 共同提高
- 管理理念——以制度为行动指南
- 质量宗旨——零缺陷管理
- 品行标准——预防为主 反应迅速
- 服务原则——谦逊的做人态度 扎实的做事风格

Corporate Value

Creating outstanding product is promoting social progress

Business Philosophy

Cooperation and development together

Management Philosophy

With the system as the guide to action

Quality Policy

Zero defect management

Code of Conduct

Strict to prevention & fast response

Service Principle

Humble & Down-to-earth

全球优秀供应商 Global Excellent Supplier

服务于工业气体、LNG & 氢能行业

Serving Industrial Gas, LNG & Hydrogen Industry

参编多个国家标准

Participated in the compilation of multiple national standards

拥有108项专利

Products already hold 108 patents



低温储罐系列

Cryogenic Tank Series



气化器系列

Vaporizer Series



撬装系列

Skid Series

公司发展与服务比例

Business development & service percentage

公司产值 Sales Level

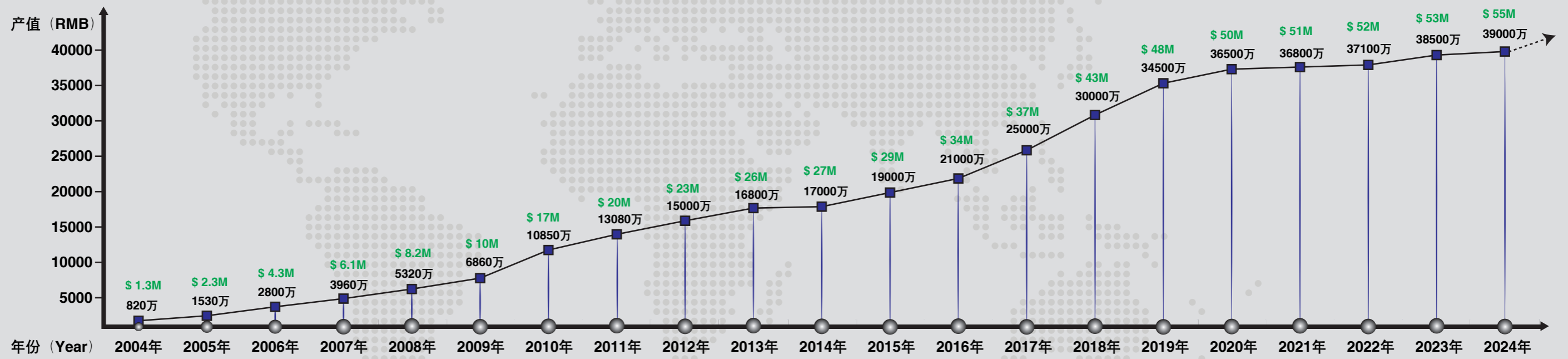

服务行业比例 Served Industries Percentage

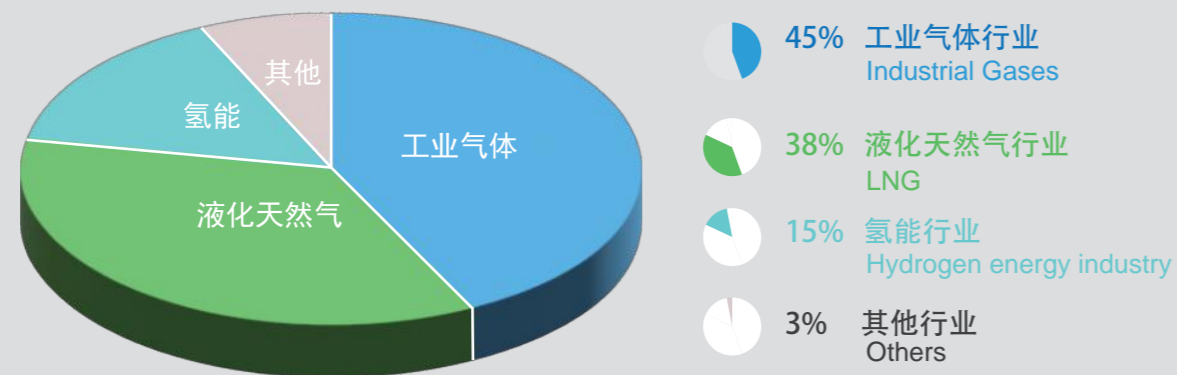

产品销售比例 Sales Percentage

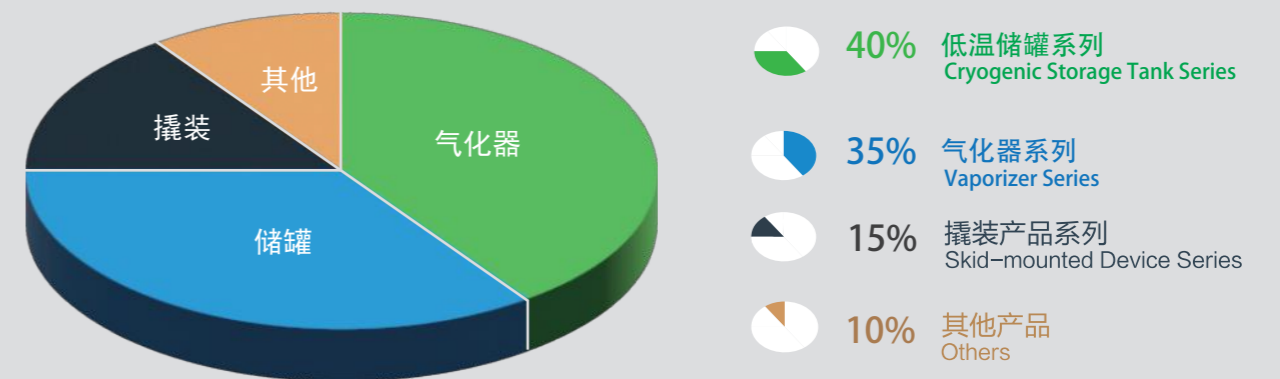

领导关怀
Leadership Caring

优秀团队
Excellent Team



特莱姆评为滨湖区2012重点建设项目并签约
Triumph was rated the binhu district 2012 key construction projects and signing



无锡市委副书记徐劫参观特莱姆
Deputy secretary of the municipal party committee of Wuxi - Mr. Xu Jie Visiting Triumph



市政府领导来特莱姆考察调研
The municipal government leaders attending conference Triumph



无锡市委常委袁飞一行来公司考察
Wuxi city Municipal Standing Committee Yuan Fei Visiting Triumph



无锡滨湖区统战战部领导慰问特莱姆
The United Front Work of Binhu District visiting Triumph



原无锡滨湖区徐永强副区长一行来公司考察调研
Former Vice Deputy Head of Binhu District - Mr. Xu Yongqiang Visiting Triumph



美国APCI总部考察特莱姆
APCI headquarters in the U.S. processing inspection in Triumph plant



特莱姆董事长与外商进行商务会谈
The chairman of Triumph having business meeting with foreign businessman



公司管理层会议
Company management meeting

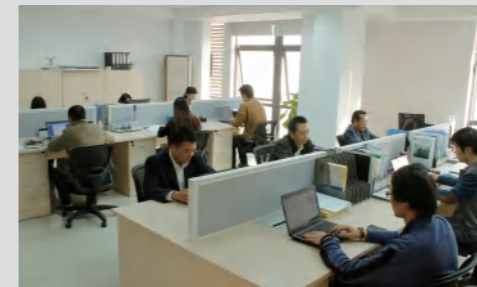

公司销售部
Company sales department



庆祝员工生日
Celebrate employees' birthday



拓展活动
Additional activities



公司管理层旅游合影
Company management travel photo



特莱姆足球&篮球俱乐部冠军奖杯
"Triumph" Football and Basketball Club Trophies



乒乓球活动
Table tennis activities



特莱姆足球队
"Triumph" Football Club



特莱姆足球队
"Triumph" Football Team



特莱姆健康跑团
"Triumph" Healthy Running Club

公司资质 Certificates

公司荣誉 Awards



三类压力容器制造许可证
Manufacture Licence for Third Category Pressure Vessel



压力管道元件制造许可证
Manufacture Licence for Pressure Pipeline Components



压力管道安装许可证
Class Pressure Vessel Manufacture License



美国ASME认证
ASME Certificate



NB国际注册
NB registered Certificate



欧盟CE证书
CE certificate for EU



加拿大CRN认证
Canada CRN Certificate

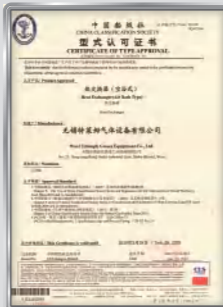

CCS认证(空浴式)
CCSCertificate(Ambient Vaporizer)

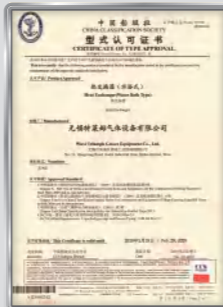

CCS认证(水浴式)
CCSCertificate(Water-Bath Vaporizer)



中核集团合格供应商
Qualified supplier for China National Nuclear Corporation



SGS证书
SGS certificate



质量管理体系认证
Quality Management System Certificate



环境管理体系认证
Environment Management System Certificate



职业健康安全管理体系认证
Occupational Health and Safety Management System Certificate

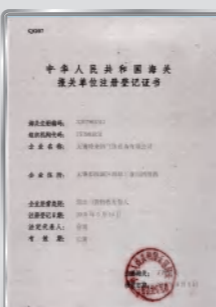

进出口证
Certificate of Import & Export



获108项国家专利
108 National Patents

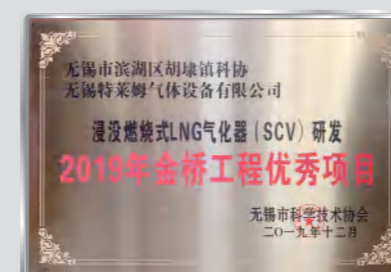
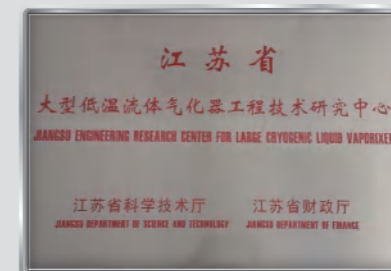
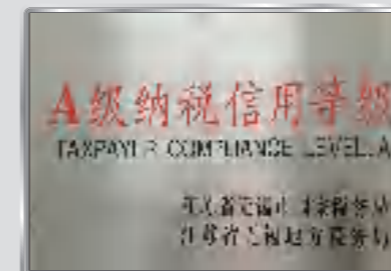
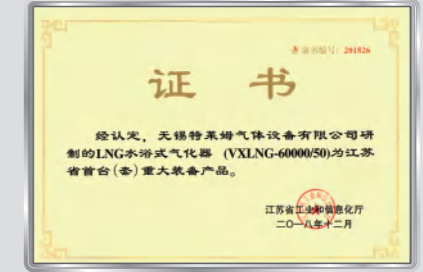
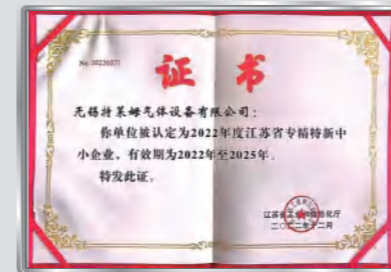
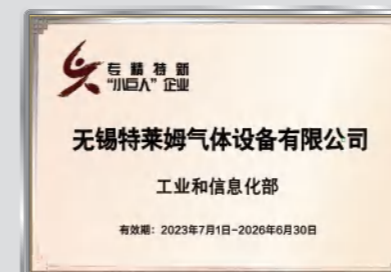

低温液体储罐系列

Cryogenic Liquid Storage Tank Series

低温液体储罐特点

Cryogenic Liquid Storage TANK Features

特莱姆低温液体储罐采用独特的高真空绝热技术，具有卓越的绝热性能，持久的真空保持时间，极低的使用成本。模块化的管路系统以及高配置部件提高了设备的使用性能和耐久性，并降低了维护成本，从而大大提升产品竞争优势。

特莱姆低温液体储罐，可严格按照 GB、ASME、CE 等国家标准设计和制造，广泛应用于液态天然气、液氧、液氮、液氩、液态二氧化碳、液态氦气、液氢、液态乙烯等深冷液体的贮存及使用，具有各种不同的工作压力和规格。迷你罐（快易捷）容积为 2m³~7.5m³，工作压力为 1.6Mpa~3.6Mpa；标准罐容积为 5m³~200m³，工作压力为 0.8Mpa~1.6Mpa。

TRIUMPH cryogenic liquid storage tanks use unique high vacuum insulation technology, with excellent insulation performance, long-lasting vacuum holding time, and extremely low cost of lifetime. Modular piping systems and high-configuration components improve the performance and durability of the equipment and reduce maintenance costs, thereby greatly enhancing the competitive advantage of products. TRIUMPH cryogenic liquid storage tanks can be designed and manufactured in strict accordance with regards to national standards such as GB, ASME, and CE. They are widely used in the storage and use of cryogenic liquids such as liquid natural gas, liquid oxygen, liquid nitrogen, liquid argon, liquid carbon dioxide, liquid helium, liquid hydrogen, and liquid ethylene, with various working pressures and specifications. Micro-tanks have a volume of 2m³~7.5m³ and a working pressure of 1.6Mpa~3.6Mpa; standard tanks have a volume of 5m³~200m³ and a working pressure of 0.8Mpa~1.6Mpa. Trium can also design and manufacture cryogenic liquid storage tanks with a volume of 200m³ or more with respect to customer needs, and can provide various specifications of vaporizers, pressure regulating and metering skids, gas buffer tanks, combined pressure regulating devices (PCM) PLC station control systems (remote) and other supporting equipment for gas applications, and can provide customers with EPC one-stop general contracting services.



特易捷迷你罐

TRIUMPH Micro-tank



液氢储罐系列

Liquid Hydrogen Storage Tanks Series

液氢储罐特点

Liquid Hydrogen Storage Tanks Features

特莱姆液氢储罐系列严格按照 ASME、CE、GB150、GB18442 等国家和企业标准进行设计和制造。该液氢储罐采用了独特的高真空绝热技术和先进的结构设计，产品具有卓越的绝热性能，持久的真空保持时间，极其安全的产品质量，极低的使用成本。模块化的管路系统以及高配置部件提高了设备的使用性能和耐久性，并降低了维护成本，广泛应用于液态氢气的贮存及现场使用。产品具有各种不同的工作压力和容积规格并有立式和卧式结构可选择。

标准罐容积 5m³~200m³，工作压力 0.1MPa~1.6MPa。可按照客户要求定制。

Triumph's liquid hydrogen storage tank series is designed and manufactured strictly in accordance with national and enterprise standards such as ASME、CE、GB150 and GB18442. This liquid hydrogen storage tank adopts unique high vacuum insulation technology and advanced structural design. The product has excellent insulation performance, long-lasting vacuum holding time, extremely safe product quality, and extremely low operating costs. The modular piping system and high configuration components improve the performance and durability of the equipment, and reduce maintenance costs. It is widely used in the storage and on-site use of liquid hydrogen gas. The products have a variety of different working pressure and volume specifications and are available in vertical and horizontal structures.

The standard tank has a capacity of 5m³~200m³ and working pressure of 0.1MPa~1.6MPa. Customization can be made according to customer requirements.



卧式或立式液氢储罐可直接用于客户用气终端或液氢加气站等应用场景

Horizontal or Vertical Liquid Hydrogen Storage Tanks can be used directly in applications such as customer gas terminals or liquid hydrogen refueling stations



2021年10月，由特莱姆制造的世界首座船用高真空薄膜型液氢储运燃料舱获得第三方SGS风险评估和检测合格，并获得英国劳氏船级社（LR）和中国船级社（CCS）的设计原理证书和建造完工证书。

In October 2021, the world's first high-vacuum thin-film liquid hydrogen storage and transportation fuel tank manufactured by Triumph was qualified for third-party SGS risk assessment and testing, and obtained the design principle certificate and construction completion certificate from Lloyd's Register of Shipping (LR) and China Classification Society (CCS).

冷箱产品系列

Cold Box Product Series

冷箱产品特点

Cold Box Product Features

特莱姆生产的液氢、液氦系列真空冷箱外壳已广泛应用于法国液空、中科院等客户。产品均采用 3D 设计软件进行全方位内外系统设计，以及采用先进的制造装备和工艺、丰富的制造经验来保证产品的高品质高性能。

冷箱产品的材质有碳钢、不锈钢或复合板可供用户选择。可按照用户要求定制。

The liquid hydrogen and liquid helium vacuum cold box shells produced by Triumph have been widely used by customers such as French Air Liquide and the Chinese Academy of Sciences. All products are designed by using 3D design software for comprehensive internal and external system design, and advanced manufacturing equipment and processes, as well as rich manufacturing experience are used to ensure high-quality and high-performance products.

Cold box material are available in carbon steel, stainless steel, or composite plates for users to choose. Can be customized according to user requirements.

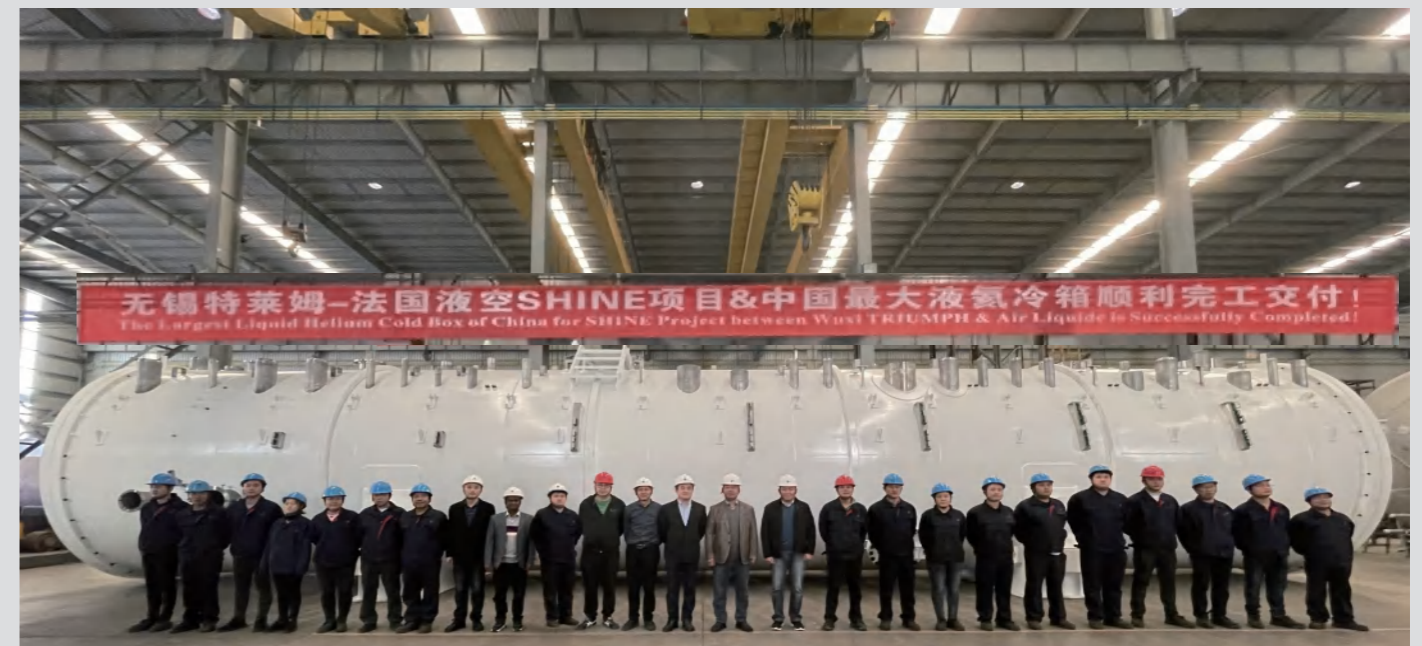

特莱姆系列产品 TRIUMPH Series Products



空温式气化器系列 Ambient Vaporizer Series



液化空气无锡华虹电子气项目
18X7500Nm³/h 气化器现场
Electronics Gas Project for AL Wuxi HuaHong,
18X7500Nm³/h ambient vaporizers



林德气体10x12000Nm³/h空温气化器项目现场
Linde 10x12000Nm³/h Ambient Vaporizer Project Site



AP沙特吉赞项目15x8000Nm³/h空温式气化器现场
15x8000Nm³/h Ambient Air Vaporizer for
AP Saudi Arabia Jazan Project



广钢气体16x10000Nm³/h空温气化器项目现场
G-gas 16x10000Nm³/h Ambient Vaporizer Project Site



中海油潮州
16x9500Nm³/h分体式气化器现场
16x9,500Nm³/h Split Vaporizer
for CNOOC Chaozhou

空温式气化器特点 Ambient Vaporizer Feature

本系列气化器是利用空气自然对流加热换热管中的低温液体 (LOX、LIN、LAr、LCO₂、LNG、LH₂、LC₂H₄、LPG 等), 使其完全蒸发成气体的一种高效节能换热设备, 其主要优点在于:

This serial vaporizer utilizes air natural convection to heat the cryogenic liquid (LOX, LIN, LAr, LCO₂, LNG, LH₂, LC₂H₄, LPG, etc.) in the heat exchange tubes, making them totally evaporate into gases, it is a kind of high efficient energy-saving heat transmission equipment. Its major advantage lies in:

- 无能耗、无污染、绿色环保
- 安装简便、维护方便
- 采用获专利的高效铝翅片换热, 轻量化设计、使用寿命长
- 特殊的 $\phi 200$ 超大直径专用铝制换热管, 化霜速度极快, 有效的内翅片结构, 提高换热管的换热效果
- “桥”式连接元件美观大方, 工作时消除各部位热胀冷缩产生的应力
- 优化流程设计, 使压降降到最低, 绝无偏流现象, 保证流速控制在安全范围以内
- 特殊的换热管表面抗氧化处理工艺
- 充足的设计裕量
- 先进的高压管复合技术, 使受压管与换热管 100% 充分接触, 保证了换热效率
- 所有气化器完全按照氧服务标准进行清洗和制造, 使用更安全
- 可按电子级标准设计、制造
- 设计条件: 环境温度 -10℃、相对湿度 70%, 连续使用 8-12 小时的气化量 (可根据客户要求)

Zero consumption, non-pollution, environmentally friendly.

Easy to install and maintain.

Patented efficient aluminum material for heat exchanging, light weight design, and durable. using special aluminum material heat exchanging pipe with diameter $\phi 200$ and can melt the frost very quickly, the using of effective structure of internal wing has made the heat exchanging pipe more effective.

The bridge style connecting component sees pretty, and also can eliminate the stress that has been generated because of the expanding by heating and the shrinking by cooling.

Special process of the anti-oxidation method on the surface of heat exchanging pipe.

optimization of flow design has minimized pressure drop, and eliminated the deflection phenomenon, and then it can control the speed of flowing within safe range.

Advanced and complex technique of high-pressing pipe makes the under pressing pipe has a sufficient contact with the heat exchanging pipe, and ensures the efficiency of heat exchanging.

All the vaporizer's manufacturing and cleaning are according to the standard of oxygen service, which is much safer for usage.

The vaporizers can be designed and manufactured due to electronic standard.

Design specifications: ambient temperature: -10%, relative humidity 70%, continuously works for 8-12 hours.

- 说明: 影响气化量的因素有: 工作周期、环境温度、湿度、海拔高度、风力、光照、使用压力、相临建筑物等

Remark: elements to influence the vaporization volume: cycle of working, ambient temperature, humidity, height above the sea level, wind power, illumination, the operating pressure nearby buildings, etc.

- 适用介质: LOX、LIN、LAr、LCO₂、LNG、LH₂、LC₂H₄、LPG 等
- 工作压力: 0.8-100.0MPa
- 单台流量: 50-16000Nm³/h
- 执行标准: GB、ASME、PED (CE)、CCS、CASC

Suitable medium: LOX, LIN, LAr, LCO₂, LNG, LH₂, LC₂H₄, LPG, etc.

Work pressure: 0.8-100.0MPa

Capacity: 50-16000Nm³/h

Standard: GB, ASME, PED (CE), CCS, CASC

注: 更大流量可采用组合式

Remark: If larger flow, we can use the combination units.

循环水及蒸汽加热式气化器系列 Circulating Water & Steam Heating Vaporizer



保利协鑫电厂大型温水循环 LNG 气化器
Large LNG Warm Water Circulating Vaporizer for SCL

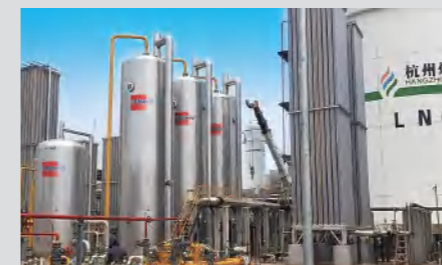

杭州燃气集团30000Nm³/h循环水LNG气化器
30,000Nm³/h LNG Circulating Water Vaporizer for Hangzhou Gas Group



合肥燃气60000Nm³/h LNG 气化器&U型管板NG加热器
60,000Nm³/h LNG Water-bath Vaporizer and U-tube plate Heater for Hefei Gas Group



50000Nm³/h U型管板LNG气化器
50000Nm³/h U tube-plate LNG Vaporizer

循环水及蒸汽加热式气化器特点 Circulating Water & Steam Heating Vaporizer Feature

本系列气化器是利用循环水或蒸汽加热筒体内的水, 再加热紧凑型换热管内低温液体 (LOX、LIN、LAr、LCO₂、LNG、LH₂、LC₂H₄、LPG), 其运用了国际先进的蒸汽恒温控制系统, 工作时气化量极其稳定, 出口温度为常温或可按用户要求设定, 其主要特点如下:

Cryogenic liquid (LOX, LIN, LAr, LCO₂, LNG, LH₂, LC₂H₄, LPG, etc.) in heat exchange tube shall be heated either by circulating water or by water that is heated by steam. It uses internationally advanced steam temperature constant control system, with stable gasification volume. Outlet temperature is constant temperature or set by the customers. Its main features are as follows:

- 采用获专利的高效换热管流程设计
- 采用优质低温专用不锈钢换热管, 紧凑设计, 经久耐用
- 采用英国 SPIRAX-SARCO 蒸汽专用控制阀双路设计, 确保不间断连续使用
- 采用英国 SPIRAX-SARCO 蒸汽专用喷射装置, 工作更安静, 无噪音及震动
- 进口油漆, 表面质量更永久
- 采用 LG 热水专用循环泵, 水温均衡无分层现象
- 均按氧标准、食品级标准制造
- 配套件齐全, 每套气化器均含: 本体、蒸汽控制装置、蒸汽喷射装置、控制箱、液位计、温度计、进水阀、排污阀等

Patented efficient heat exchange pipeline process

Superior cryogenic stainless steel heat exchange pipe is employed, durable

U.K SPIRAX-SARCO steam exclusive control valve double-way design ensures continuous use

U.K SPIRAX-SARCO steam exclusive spraying device makes operation quiet, no noise and vibration

Imported paint, making surface quality more durable

LG hot water exclusive circulation pump is used to ensure uniform water temperature

Manufactured according to oxygen and food standard

Complete supporting components, each set of gasifier includes: main body, steam control device, steam spraying device, control box, liquid level meter, temperature meter, water inlet valve, pollution discharge valve and etc.

● 用户可选配置

- 筒体有碳钢和不锈钢等材质可选
- 出气温度高、低温声光报警
- 加装紧急切断装置
- 设备整体撬装、设计 (较小流量)
- 可按电子级设计制造
- 可设计可拆卸式换热器芯子
- 可采用防爆电控箱、防爆电加热器

Optional configurations for customers

For the materials of the tunnel body, you can choose carbon steel or stainless steel
The acousto-optic alarm of the temperature of the exits
Emergency cutting off equipment
The whole equipment is picking designed (Smaller flow)
We can design and produce according to the standard of electronic grade
It can design the shirking type heat exchanger fuse
It can adopts explosion prevention electric cabinet and explosion prevention electric heating equipment

- 适用介质: LOX、LIN、LAr、LCO₂、LNG、LH₂、LC₂H₄、LPG 等
- 工作压力: 0.8-150.0MPa
- 单台流量: 1000-100000Nm³/h
- 执行标准: GB、ASME、PED、CCS、CASC

Suitable medium: LOX, LIN, LAr, LCO₂, LNG, LH₂, LC₂H₄, LPG, etc.

Work pressure: 0.8-150.0MPa

Capacity: 1,000-100,000Nm³/h

Standard: GB, ASME, PED, CCS, CASC

电加热式气化器系列 Electric Heating Vaporizer Series

电加热式气化器特点 Electric Heating Vaporizer Feature

本系列气化器是利用特制高效率电加热器加热筒体内的水，再加热紧凑型换热管内低温液体 (LOX、LIN、LAr、LCO₂、LNG、LH₂、LC₂H₄、LPG)，采用先进的水温控制系统，工作时气化量极其稳定，出口温度为常温或可按用户要求设定，其主要特点如下：

This series carburetors heat up the water in the tunnel body by tailor-made high efficiency electric heating equipment, and then heat up the cryogenic liquor(LOX, LIN, LAr, LCO₂, LNG, LH₂, LC₂H₄, LPG) in the compact heat exchanger. It adopts the advanced water temperature control systems, and the gasification volume is very stable. The outlet temperature shall be room-temperature or customized. It's main advantage lies in:

- 特制高效率电加热器，一般更换周期为18个月以上
- 全自动及半自动双线路温控控制箱，安全可靠，可不间断工作，万无一失
- 采用优质低温专用不锈钢换热管，紧凑设计，经久耐用
- 采用进口油漆，表面质量更永久
- 采用LG热水专用循环泵，水温均衡无分层现象
- 工作更安静，无噪音及震动
- 均按氧标准、食品级标准制造
- 配套件齐全，每套气化器均含：本体、电加热器、控制箱、液位计、温度计、进水阀、排污阀等

Tailor-made high efficiency electric heating equipment, general speaking, the periodicity of replacing is more than 18 months.

Automatic and semiautomatic double circuits' temperature control box, it is safe and certifiable, can work without intermission or infallible.

It adopts high grade special cryogenic stainless steel heat exchanger, was designed compactly and will abide rough use.

The surface is painted by the imported paint, and can keep high quality more permanently.

It uses the LG hot water special circulating pump. The water temperature is statuesque and no bedding phenomena.

You will have quieter working environment without noise and shake.

It is produced by the standards of oxygen and food.

The parts are very complete, every carburetor contains: the main body, electric heating equipment, control box, liquid level meter, thermometer, inlet valve, blow down valve ad so on.

● 用户可选配置

- 筒体有碳钢和不锈钢等材质可选
- 出气温度高、低温声光报警
- 加装紧急切断装置
- 设备整体撬装、设计
- 可按电子级标准设计制造
- 可采用西门子电器
- 可采用防爆电控箱、防爆电加热器

Optional configurations for customers

For the materials of the tunnel body, you can choose carbon steel or stainless steel
The acousto-optic alarm of the temperature of the exits
Emergency cutting off equipment
The whole equipment is picking designed
We can design and produce according to the standard of electronic grade
It can use Siemens electrical apparatus
It can adopts explosion prevention electric cabinet and explosion prevention electric heating equipment

- 适用介质：LOX、LIN、LAr、LCO₂、LNG、LH₂、LC₂H₄、LPG 等
- 工作压力：0.8-150.0MPa
- 单台流量：50-20000Nm³/h
- 执行标准：GB、ASME、PED (CE)、CCS、CNNC、CASC

Suitable medium: LOX, LIN, LAr, LCO₂, LNG, LH₂, LC₂H₄, LPG, etc.

Work pressure: 0.8-150.0MPa

Capacity: 50-20,000Nm³/h

Standard: GB, ASME, PED (CE), CCS, CNNC, CASC

注：更大流量可采用组合式

Remark: If larger flow, we can use the combination units.



防爆型LPG气化器
Explosion-proof LPG Vaporizer



ASME LCO2电加热气化器
ASME LCO2 electric heating vaporizer



电加热卧式LIN气化器
Electric Heated Horizontal LIN Vaporizer



电加热LCO₂气化器
Electric Heated LCO₂ Vaporizer



提供给韩国三星EP级电子气水浴式气化器
Electronics Gas Project for Samsung, EP grade Water-bath vaporizer

燃烧式气化器系列 Combustion Vaporizer Series

浸没燃烧式气化器特点 Submerged Combustion Vaporizer Feature

本 SCV 为我公司与上海交大联合研发的成果，属国内首创并已获得多项国家专利。SCV 主要气化大流量的 LNG 或其他低温介质，是充分利用天然气燃烧产生的高温烟气为热源，高温烟气在水中产生剧烈扰动并高效加热浸没在池中的 LNG 换热盘管，换热效率极高，设备占地小，自动化程度高，气化量不受气候影响。气化负荷可从 10~110% 之间任意调节。

This SCV is the achievement of joint research and development between Triumph and Shanghai Jiaotong University. It is the first one developed in China and has obtained several national patents.

SCV mainly gasifies large flow of LNG or other cryogenic medium. It makes full use of the high-temperature flue gas generated by natural gas combustion as the heat source. The high-temperature flue gas causes severe disturbance in the pool and efficiently heats the LNG heat exchange coil immersed in the pool. The heat exchange efficiency is very high, the equipment occupies a small area, with a good automation, and the gasification capacity is not affected by the climate. The gasification load can be adjusted arbitrarily from 10 - 110%.



燃烧式气化器特点 Combustion Vaporizer Feature

特莱姆燃烧式气化器系列均采用整体撬装设计、结构紧凑型高效换热设备。可采用天然气或柴油等燃料在炉膛中进行充分燃烧来获得高温烟气，烟气加热炉膛和换热烟管，使水浴池中的水温迅速上升后加热低温介质的换热管束，使低温介质达到一定温度的高效换热设备。本系列产品有一键启动功能和 PLC 全自动控制和运行功能，并设有各种安全报警和切断等功能安全可靠，设备紧凑占地少且热效率高，可根据要求达到各种环保排放要求。单台流量：5000~60000Nm³/h。气化介质：LN₂、LO₂、LAr、LNG、LC₂H₄、LPG 等。压力范围：0.8~200.0MPa。可按照客户要求定制。

Triumph's combustion vaporizer series adopts an integral skid design, compact structure, and high-efficiency heat exchange equipment. Natural gas or diesel fuel can be fully burned in the furnace to obtain high-temperature flue gas. The flue gas heats the furnace and heat exchange flue gas tubes, causing the water temperature in the water pool to rapidly rise and then heating the cryogenic medium heat exchange tube bundle, making the cryogenic medium reach a certain temperature. This is an efficient heat exchange equipment. This series of products has one key start function and PLC fully automatic control and operation function, as well as various safety alarm and cut-off functions, which are safe and reliable. The equipment is compact, occupies less space and has high thermal efficiency, and can meet various environmental emission requirements.



空分后备供气现场
Air separation backup gas supply site

天然气应急供气现场
Natural gas emergency supply site

中间介质气化器系列 Intermediate Fluid Vaporizer Series

中间介质气化器特点 Intermediate Fluid Vaporizer feature

特莱姆IFV气化器系列产品为自主研发、设计和制造的高科技产品，产品技术已获得了国家发明专利。IFV主要利用海水或电厂等大流量循环水来加热中间介质，再间接加热换热器内的LNG，使LNG气化后达到一定温度的高效、低能耗气化设备，一般主要应用于长江或海边LNG接收站。

特莱姆IFV气化器比传统结构更加合理且热效率高，运行成本低、还可避免IFV现场二次安装等行业痛点问题。中间介质可选择丙烷、乙二醇等相关介质。

单台流量：50~200T/h，压力范围：0.8~200.0MPa。

可按照用户要求定制。

The Triumph's IFV vaporizers are high-tech products which developed, designed, and manufactured independently, and it's technology has obtained national invention patents. IFV vaporizer is an efficient and low-energy consumption gasification equipment that mainly uses high flow circulating water such as seawater or power plants to heat the intermediate medium and heat the LNG in the heat exchanger indirectly, so that the LNG can reach a certain temperature after gasification. It is generally used in LNG receiving stations on the Yangtze River or by the sea.

The Triumph's IFV vaporizer is more reasonable and has higher thermal efficiency than traditional structures, with lower operating costs and avoiding industry pain points such as on-site secondary installation. Intermediate media such as propane and ethylene glycol can be selected.

Single unit Flowrate: 50~200T/h, Pressure range: 0.8~200.0MPa. Can be customized according to user requirements.



工业气体减压装置系列 Industrial Gases Pressure Regulating Decice Series

工业气体减压装置特点 Industrial Gases Pressure Regulating Device Feature

本调压装置均采用美国、德国或国内最优质的阀门，适用于气量为 50Nm³/h 至 20000Nm³/h，调压范围从 0~25.0MPa。

Superior valves from U.S Gerany or China are chosen for pressure regulating device, applicable flow from 50Nm³/h to 20,000Nm³/h. Pressure regulating range is 0-25.0MPa.



单路CASH减压装置
Single-way Pressure Regulating Device (CASH)



氧气、天然气、重油混合撬
Gas Mixing Skid of O2 & NG & Heavy Oil



氧气、天然气混合撬
Gas Mixing Skid of O2 & NG

LNG气化站撬装系列 LNG Vaporizing Station Skid Mounted Equipment Series



调峰站减压撬
Peaking Shaving Station & Pressure Regulating Skid



LNG气化站减压计量撬
LNG Gasification & Pressure Regulating & Metering Skid



LNG调峰站调压撬
LNG peak shaving station pressure regulating skid



空温复热式CNG减压撬(专利产品)
CNG Ambient Type Pressure Regulating Skid (Patented)



LNG集装箱式气化站
LNG Container Type Gas Station



L-CNG汽车加气撬
L-CNG Car Filling Skid

PLC站控系统 PLC Station Control System

■ 可为用户定制各种要求的PLC站控系统（含无人值守系统）
Customized PLC control system (unattended)

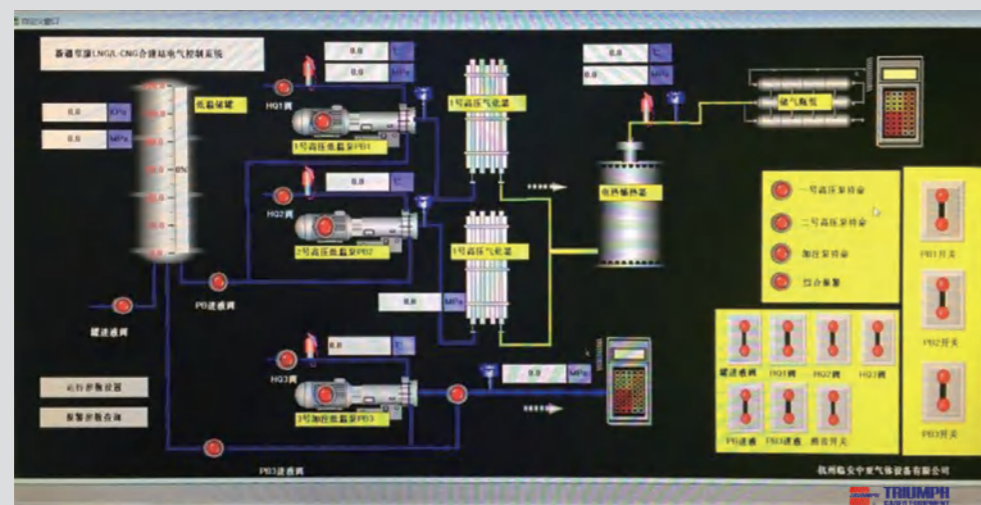
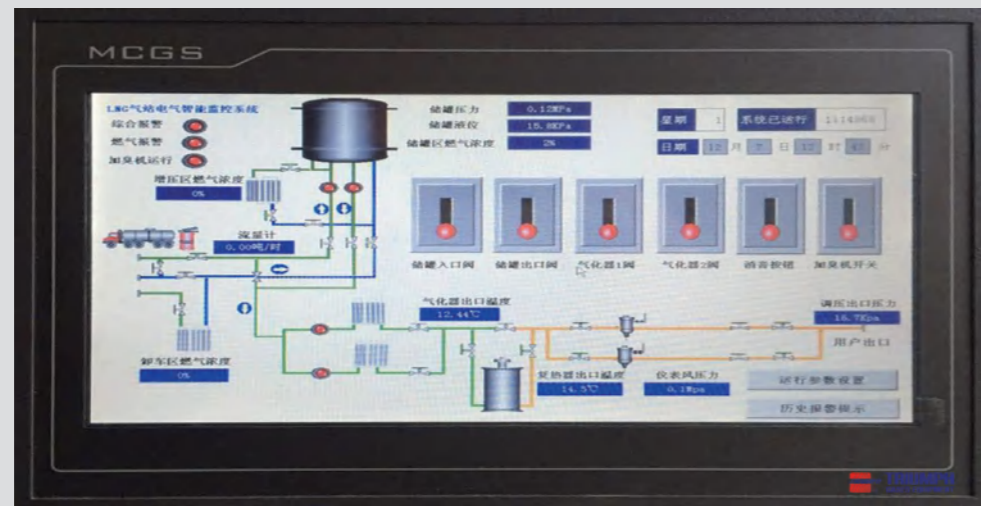
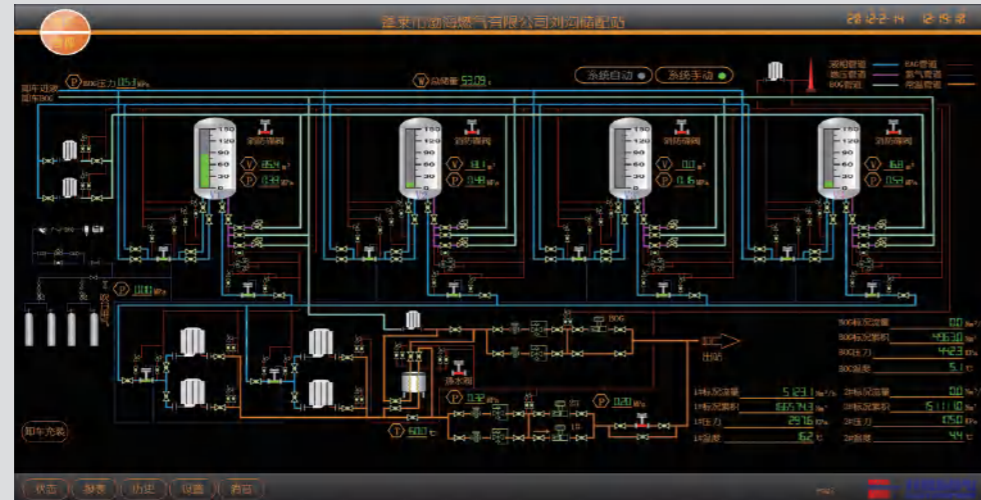

气化站项目EPC总包 Vaporizing Station EPC Turnkey Project



滁州广钢气体气化站EPC总包
Chuzhou G-Gas gasification station EPC project

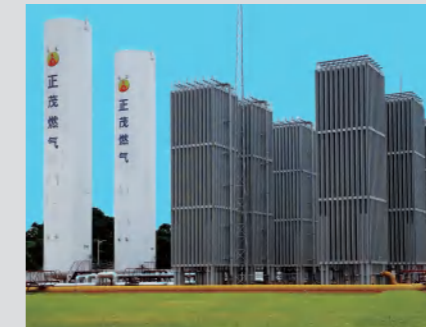

广东清新正茂燃气LNG气化站EPC总包
Guangdong Qinxin Zhengmao Gas LNG Gasification Station



兰州中油昆仑燃气LNG气化站EPC总包
Lanzhou Petro China Kunlun Gases Gas LNG Gasification Station



港华燃气LNG气化站项目EPC总包
LNG gasification EPC project for Towngas Co.



华润燃气LNG气化站项目EPC总包
LNG gasification EPC project for China Resources Gas Co.



青海隆鑫燃气LNG、L-CNG项目EPC总包
Qinghai the Loncin Gas LNG, L-CNG Project



务川新兴燃气LNG、L-CNG项目EPC总包
Wuchuan Emerging Gas LNG, L-CNG Project



福建奋安铝业LNG气化站EPC总包
Fujian Fenan Aluminum LNG Gasification Station

融资租赁业务

Financial Leasing Business

租赁方式: 单体设备租赁、成套设备租赁.....

租赁设备: 低温贮槽、气化器、减压计量撬、LNG气化减压一体撬、煤改气全套供气设备、LNG气化站全套设备、LCNG加气站全套设备.....

Leasing Method: Individual equipment or Complete Ser of Equipment...

Equipment for Lease: Cryogenic Storage Tank
Vaporizer
Pressure Regulating & Metering Skid
LNG Gasification & Pressure Regulating Skid
Coal-to-gas Gas Supply Equipment
LNG Gasification Station
L-CNG Filling Station...



品牌代理

Brand Agency



LNG加气机
LNG Dispenser

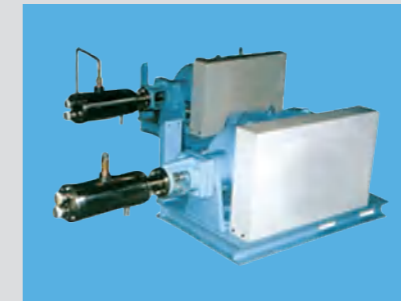

低温液体泵
Cryogenic Liquid Pump



低温杜瓦瓶
Cryogenic Dewar



高压贮气瓶
High-pressure Tube Bundles



高精度气体配比器
High-precision Gas Mixer



进口低温阀门
Imported Cryogenic Valve



双泵加臭机
Twin-pumps Odorizer



高压钢瓶
High-pressure Cylinder



智能充装台
Intelligent Charging Station



Triumph

> 品质源于专业 <

Quality Based On Profession

产品使用现场 Product Jobsite



大连华润燃气公司空温式LNG气化器现场
Jobsite of Dalian China Resources Gas
LNG Ambient Vaporizer



徐州港华16000Nm³/h分段式气化器
Jobsite of Xuzhou Town Gas16,000Nm³/h
Splitted Vaporizer



中燃芜湖空温式LNG气化器现场
Jobsite of China Gas (Wuhu) LNG Ambient Vaporizer



河北天然气立式U型管LNG气化器现场
Jobsite of vertical U tube plate LNG
vaporizer for Hebei Natural Gas Company



湖州新奥LNG气化站现场
Jobsite of Huzhou ENN LNG Regasification Station



潮州港华空温式LNG气化器现场
Jobsite of Chaozhou Towngas
LNG Ambient Vaporizer



Air Liquide 无锡华虹电子气项目
18x7500NM³/h气化器现场
Electronics Gas Project for AL Wuxi HuaHong,
18x7500NM³/h ambient vaporizers



中海油宜兴气化器现场
Ambient Vaporizer for CNOOC Yixing



滁州广钢气体电子气气化站现场
Chuzhou G-Gas Electron gasification station

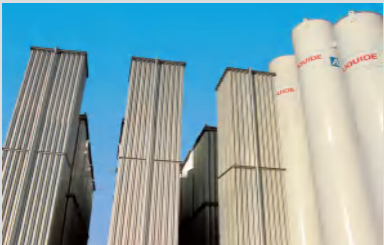

Air Liquide南京熊猫电子气空温式气化器现场
Jobsite of Air Liquide Nanjing Panda Electron Ambient
Vaporizer



Air Products空温式气化器现场
Jobsite of Air Products Ambient Vaporizer



Praxair空温式气化器现场
Jobsite of Praxair Ambient Vaporizer



Linde空温式气化器现场
Jobsite of Linde Ambient Vaporizer



AP沙特吉赞项目空温式气化器现场
Ambient Air Vaporizer for AP Saudi Arabia Jazan
Project



兰州中油昆仑LNG增压气化装置现场
Jobsite of Lanzhou Petrochina Kunlun Gas
LNG Pressurization Gasification Device Field

销售网络 Sales Network

Triumph

我们的企业理念是要让每个人都能感觉到自己的贡献，这种贡献看得见，摸得着，还能数得清。

To make every staff aware of their own contributions, which are not only visible and tangible, but also rewardable.



- 上海销售服务分公司
- 南京销售服务分公司
- 广州销售服务分公司
- 深圳销售服务分公司
- 北京销售服务分公司
- 沈阳销售服务分公司
- 成都销售服务分公司
- 武汉销售服务分公司
- ★ 台湾销售服务中心
- ★ 世界各地 28 个代理机构
28 Agencies around the world

- Shanghai branch sales & service
- Nanjing branch sales & service
- Guangzhou branch sales & service
- Shenzhen branch sales & service
- Beijing branch sales & service
- Shenyang branch sales & service
- Chengdu branch sales & service
- Wuhan branch sales & service
- Taiwan branch sales & service

20 多年来，特莱姆产品已遍布全球，已出口 80 多个国家和地区。
For more than 20 years, Triumph's products have been exported to more than 80 countries and regions.

客户现场服务 Onsite Service



为济南能源集团提供2台浸没燃烧式气化器现场
Jobsite of 2 sets SCV for Jinan Energy Group



为西宁中油燃气提供2台浸没燃烧式气化器现场
Provide 2 units SCV on-site for China Oil and Gas in Xining



特莱姆为青海玉树灾区政府援建项目提供的 LNG、LCNG 气化器、加热器现场
LNG、L-CNG vaporizers and heaters' operating site of Qinghai Yushu disaster area government reconstruction project which provided by Wuxi Triumph



温州燃气LNG调峰站
Wenzhou Gas LNG Peak Shaving Station



百川能源项目
Baichuan Energy Project

行业影响 Industry Influence

- 特莱姆是中国唯一通过所有国际气体集团认证并长期全球供货的储罐、气化器供应商。也是国际大多数燃气集团和石油集团长期供应商。
- 特莱姆是中国唯一LNG气化站（点供站）全产业链设备生产的专业公司（专业生产低温储罐、各类气化器、减压撬、站控系统.....）。
- 特莱姆是《中国燃气工程设计手册》、《城镇液化天然气（LNG）气化供气装置》、《液化天然气应急供应技术工程》、《氢气储存运输技术规范》《液氢液氮空温式气化器技术要求》等国家相关标准的主要参编单位，也是中国空分行业和燃气行业多家权威杂志、媒体的长期名誉单位。
- Triumph is the only vaporizer supplier in China that has passed the certification of all i gas Gas Group in the world and has long-term global supply.
- Triumph is the only manufacturer in china that is able to supply the whole LNG gas supply equipment(specialized in manufacturing cryogenic tanks, vaporizer, pressure regulating skids, station control system.....).
- Triumph is a major contributor to national standards such as the "China Gas Engineering Design Manual", "Urban Liquefied Natural Gas (LNG) Gasification and Supply Equipment", "Liquefied Natural Gas Emergency Supply Technical Engineering", "Technical Specification for Hydrogen Storage and Transportation", and "Technical Requirements for Liquid Hydrogen& Liquid Helium Ambient Vaporizers". Triumph is also a long-term honorary unit of several authoritative



详见手册P666-677页
See Page 666-677

公司地理位置 Location of Triumph



长期荣誉客户

Long-term Honored Customers

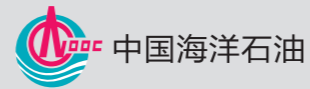

展望未来

Looking into The Future



追求卓越 开创一流

The pursuit of excellence creates a first-class brand

在特莱姆成长之路上，
追求永无止境。
前方没有终点，
未来更多希望，
梦想总是在闪耀的最前方。
前行路上，
将植根大地，一如既往，
锐意创新，创造更多辉煌。

On the growing road of Triumph
The pursuit is endless
No end in the future
More hopes in the future
Dreams are always shining in the forefront
When walking on the road
Triumph will be rooted in the earth, as always
Committed to innovation and create more brilliant.